

PMA-BLK
PMA-SIL

Hardware Pack #1

Required

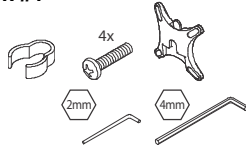

NOT Required

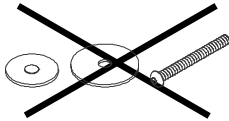

Required

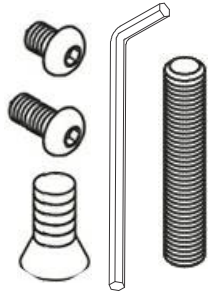

Hardware Pack #2

NOT Required

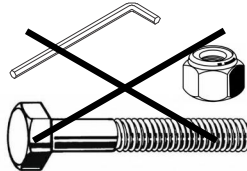

Foam Cushion



PROXIMA Lateral Monitor Arm

(PMA-BLK & PMA-SIL)

Assembly and Installation Instructions

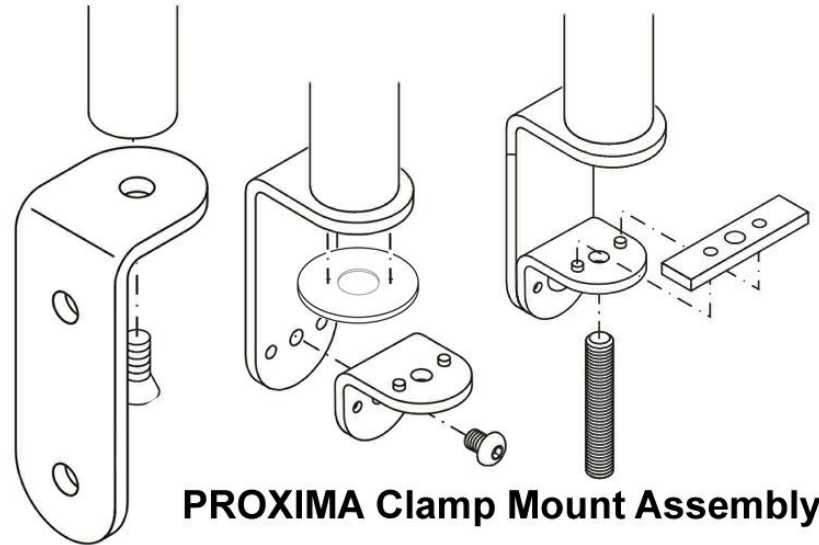

PROXIMA Clamp Mount Assembly

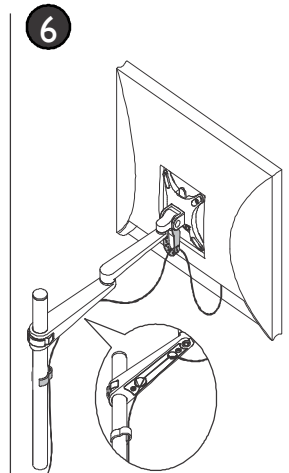
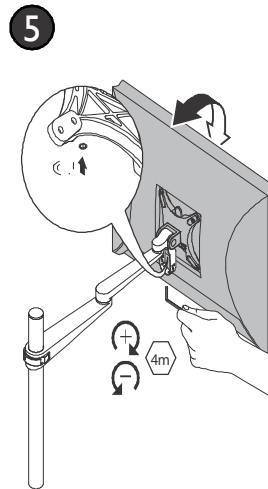
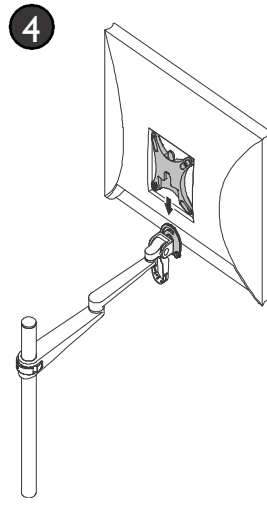
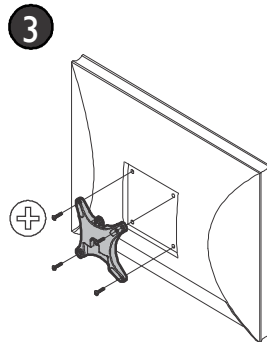
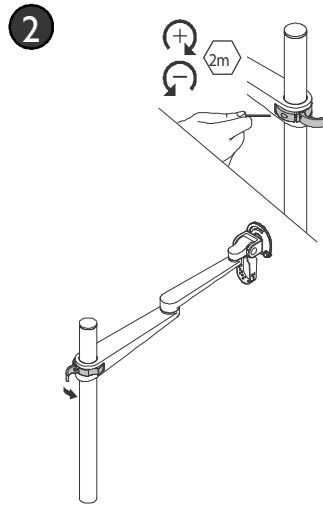
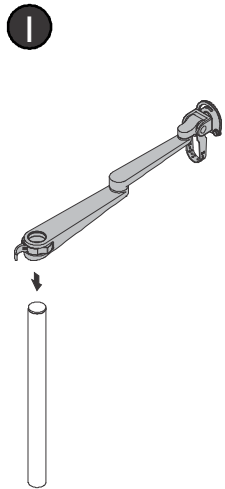

*5mm wrench not included.